

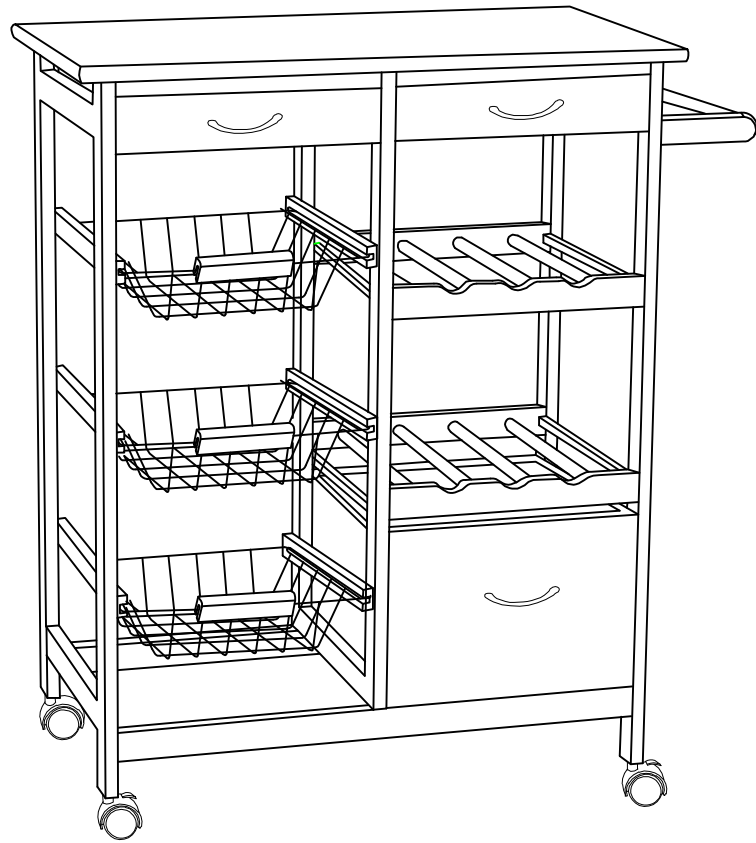

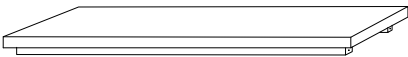

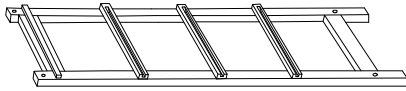

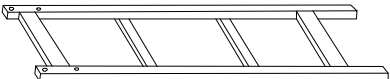

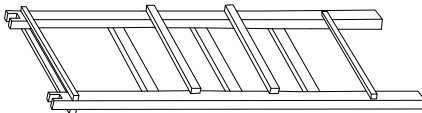

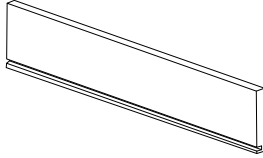
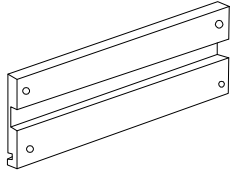
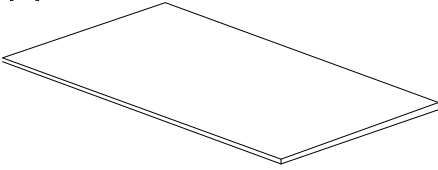
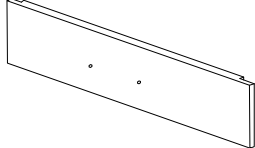
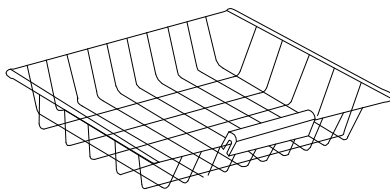
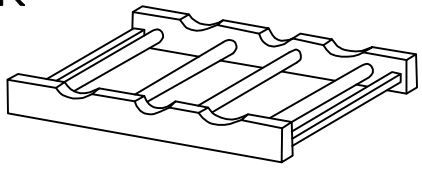
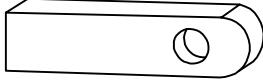
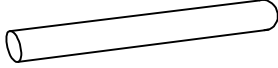
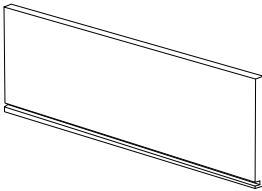
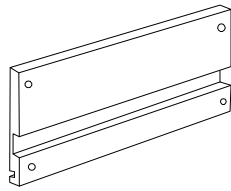
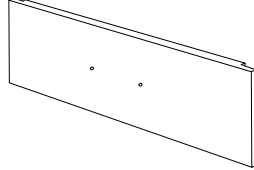
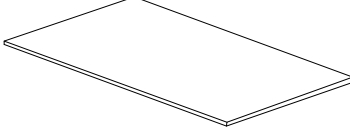
SEMIR

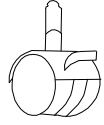
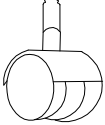
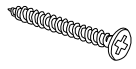
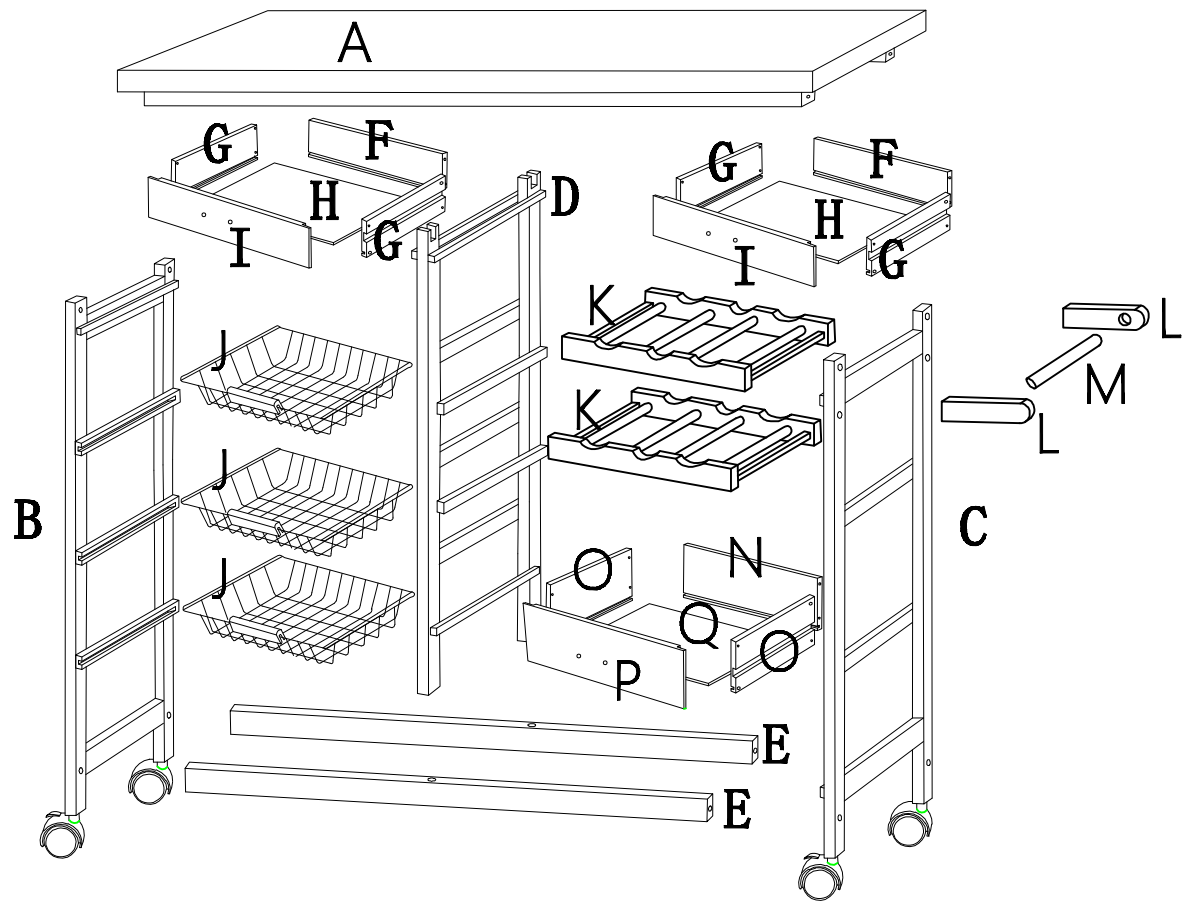

| | | |
|---|---|---|
| <p>A</p>  <p>x1</p> | <p>B</p>  <p>x1</p> | <p>C</p>  <p>x1</p> |
| <p>D</p>  <p>x1</p> | <p>E</p>  <p>x2</p> | <p>F</p>  <p>x2</p> |
| <p>G</p>  <p>x2</p> | <p>H</p>  <p>x2</p> | <p>I</p>  <p>x2</p> |
| <p>J</p>  <p>x3</p> | <p>K</p>  <p>x2</p> | <p>L</p>  <p>x2</p> |
| <p>M</p>  <p>x1</p> | <p>N</p>  <p>x1</p> | <p>O</p>  <p>x2</p> |
| <p>P</p>  <p>x1</p> | <p>Q</p>  <p>x1</p> | |

| | | | | | |
|---|---|---|---|---|---|
| <p>a</p>  <p>x12</p> | <p>b</p>  <p>x3</p> | <p>c</p>  <p>x6</p> | <p>d</p>  <p>x2</p> | <p>e</p>  <p>x2</p> | <p>f 3x25mm</p>  <p>x24</p> |
|---|---|---|---|---|---|



- 1
- | | | | | | |
|---|-------|---|-------|---|-------|
|  | a x 2 |  | d x 2 |  | e x 2 |
|---|-------|---|-------|---|-------|

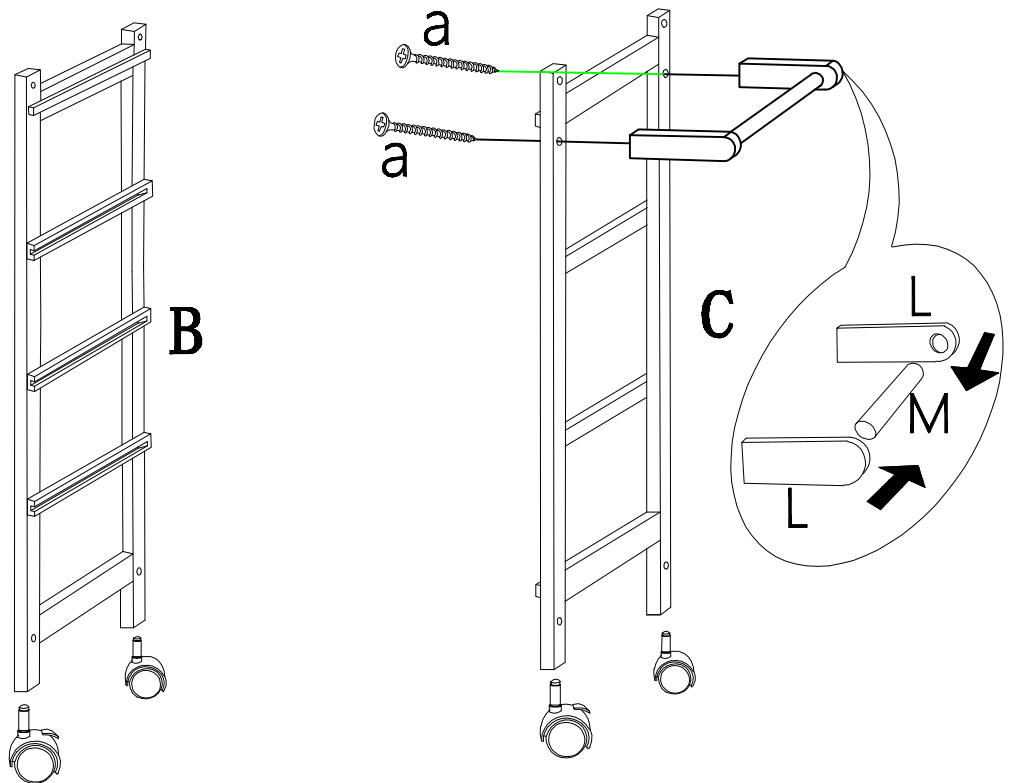

2

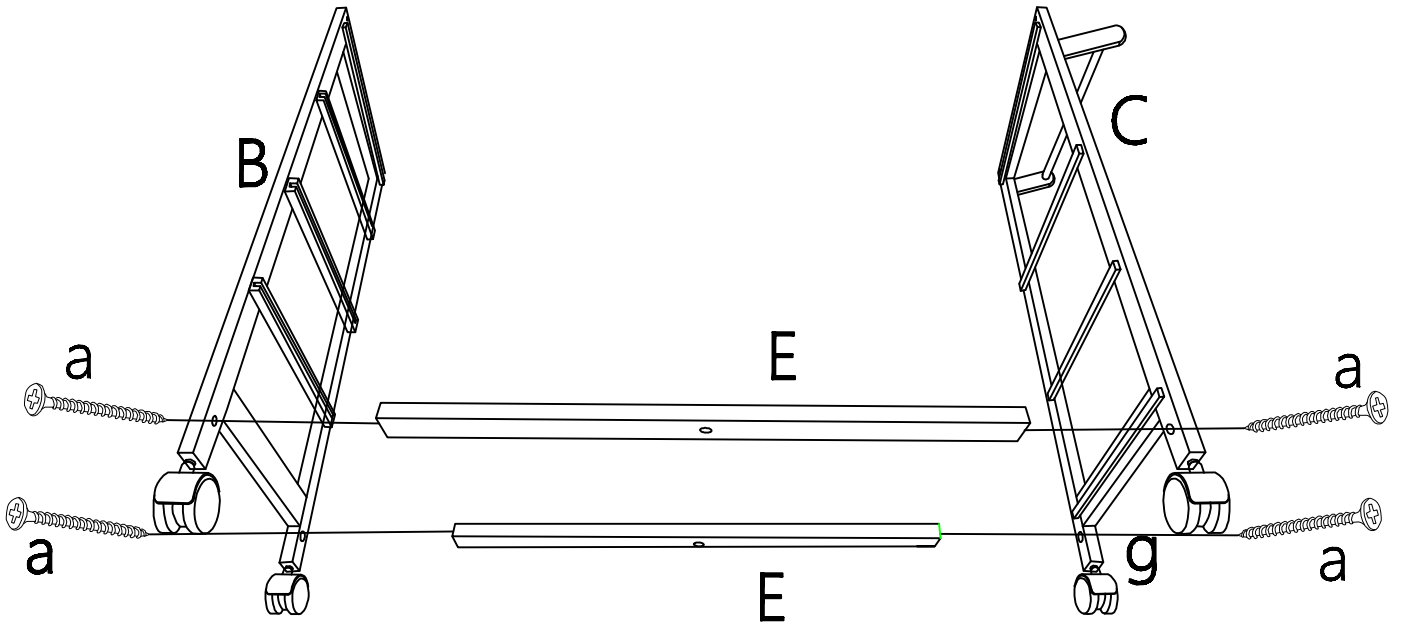
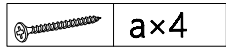

3

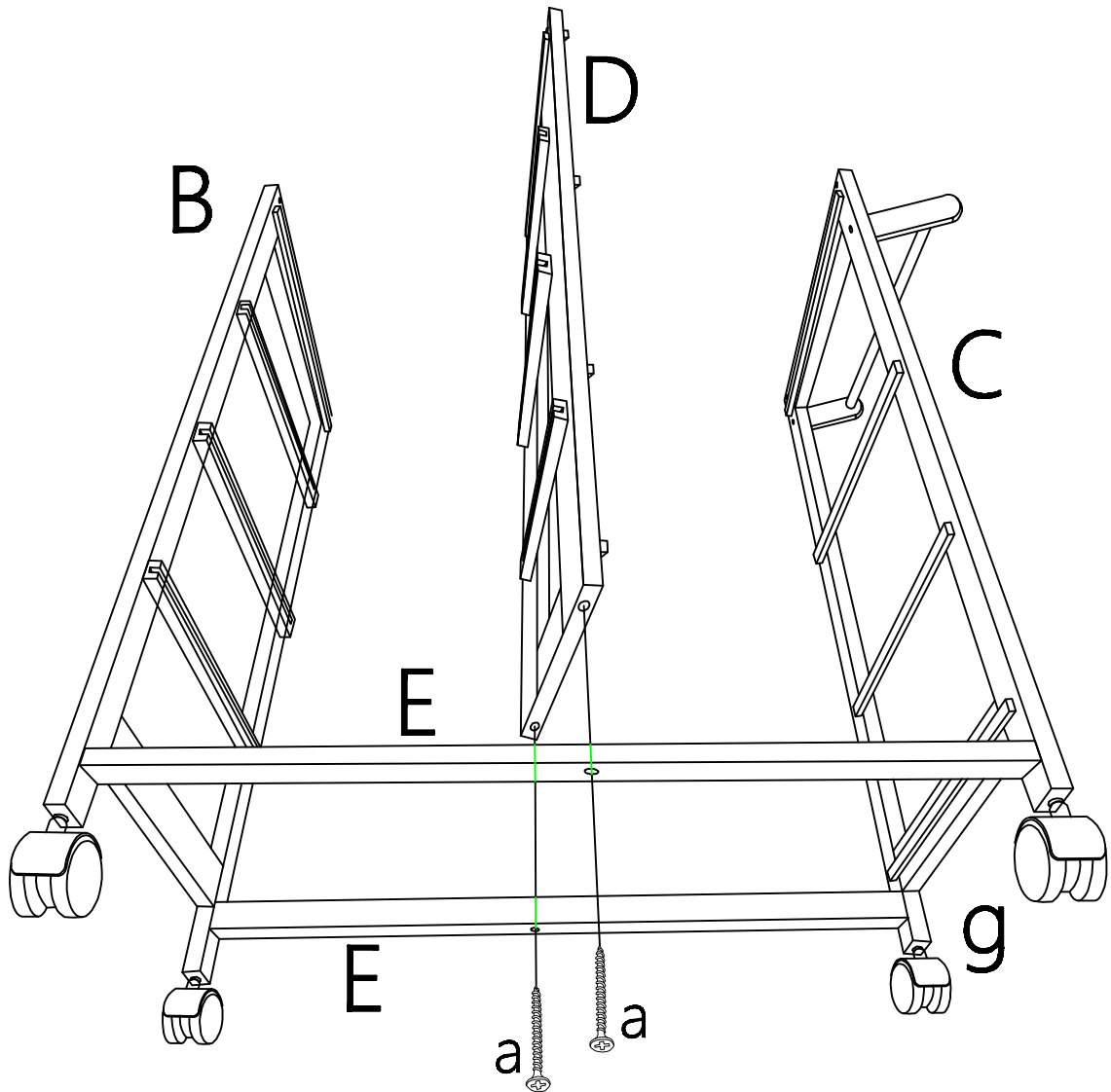
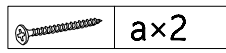

4

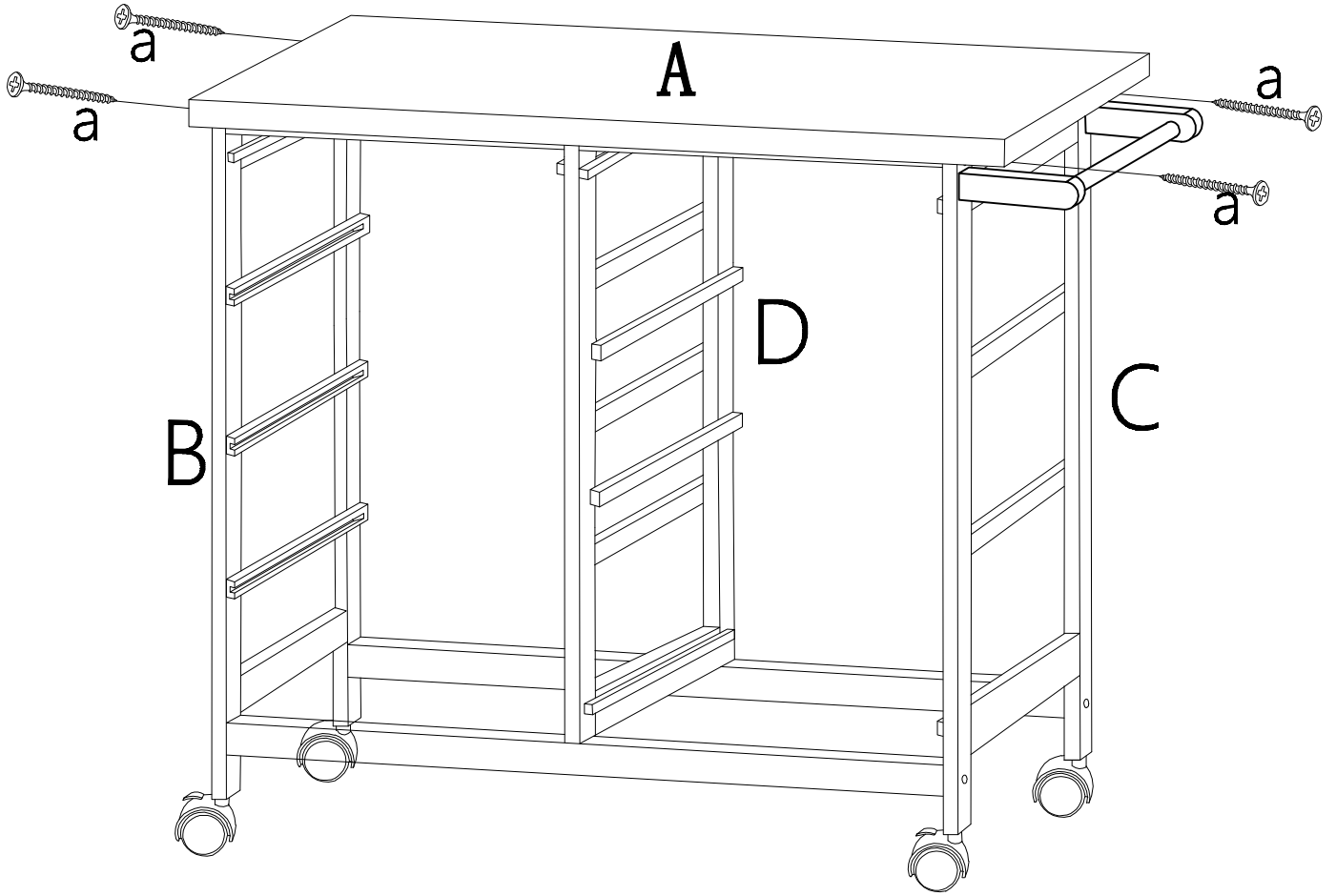
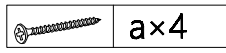

5

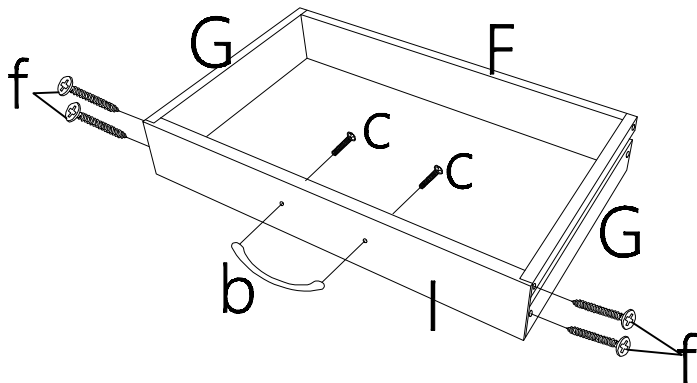
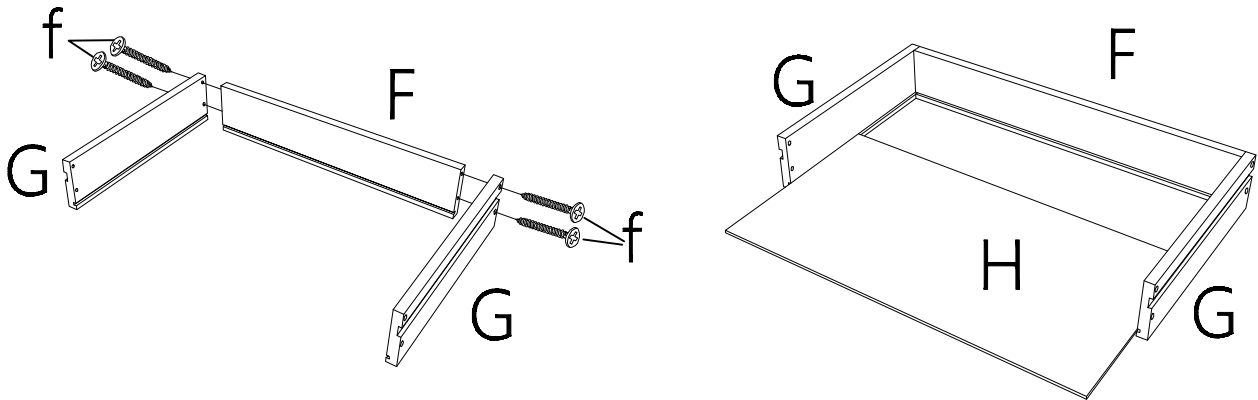
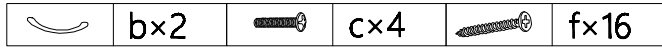

x2

6

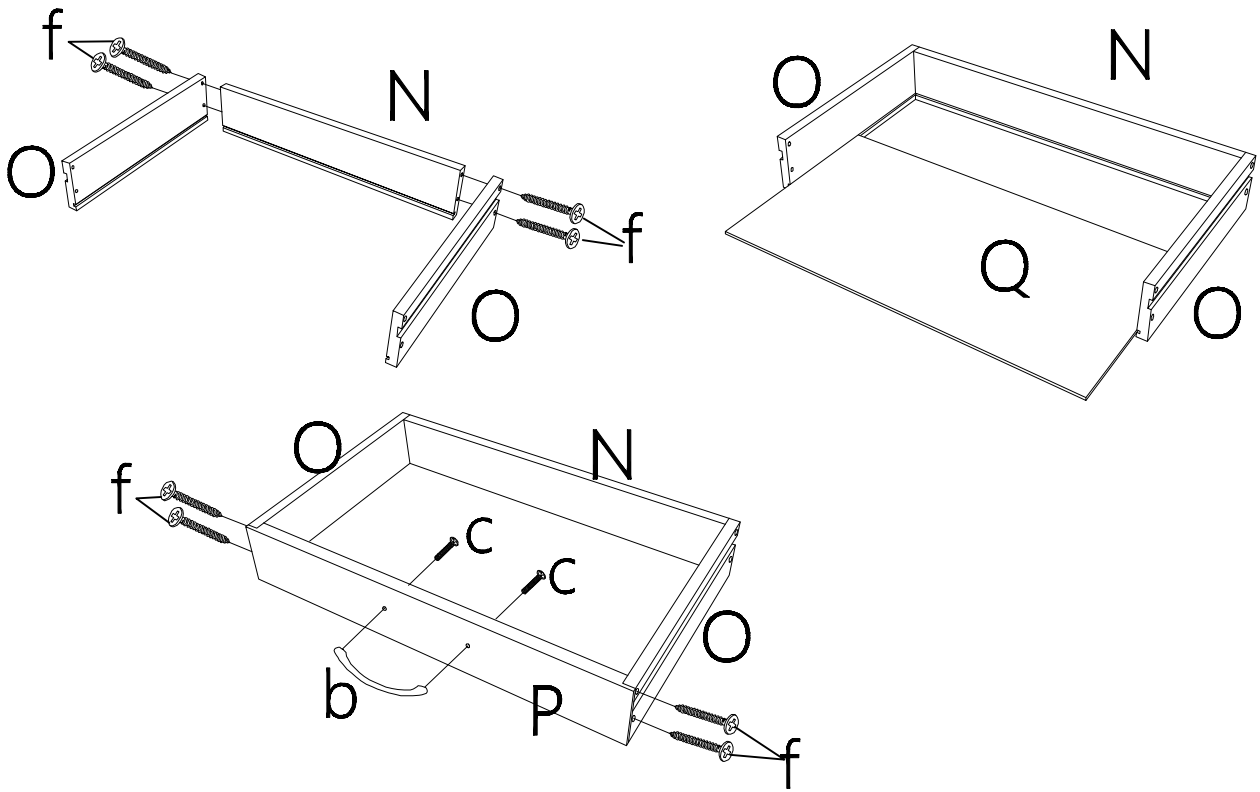
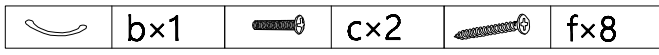

7

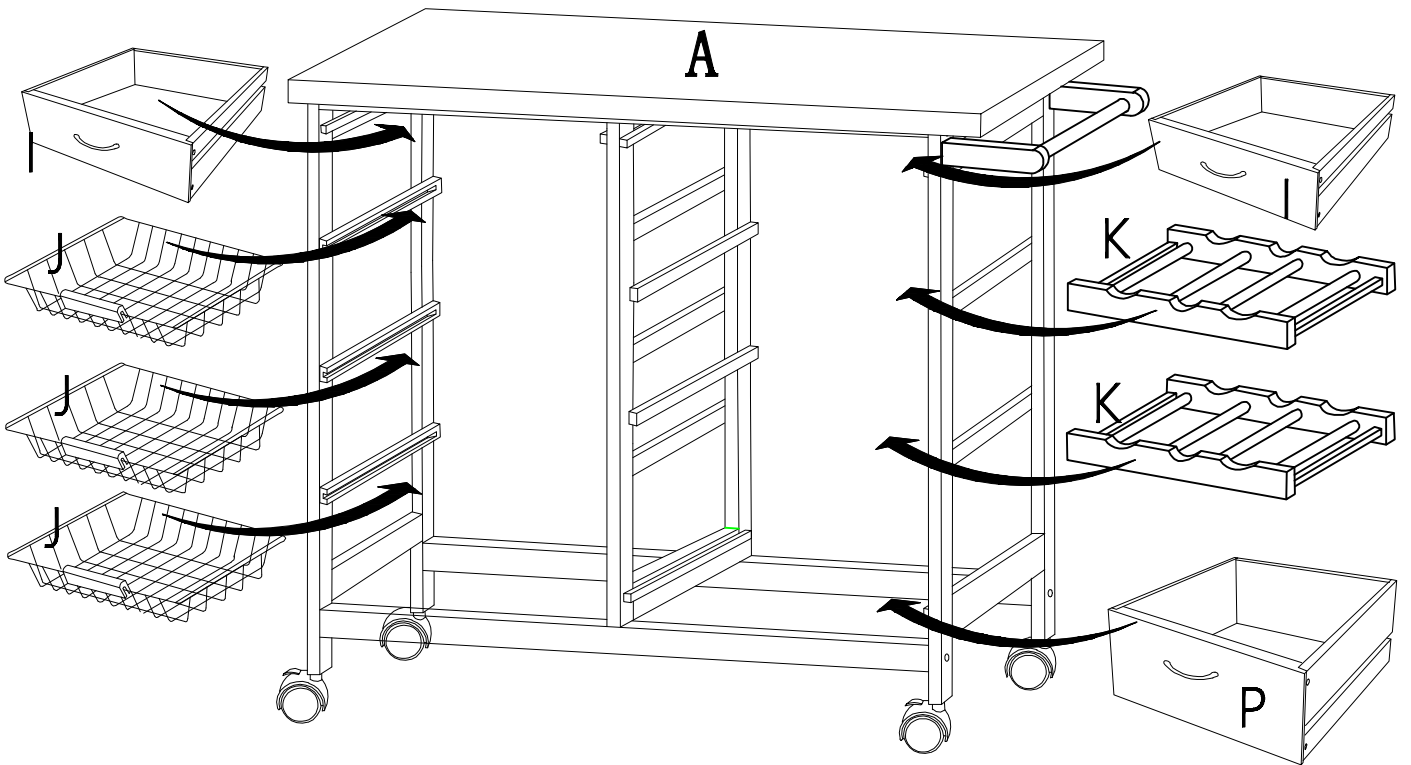

8

